

thermolineECO

Plate heat exchangers for
standard applications

DN25 - DN450

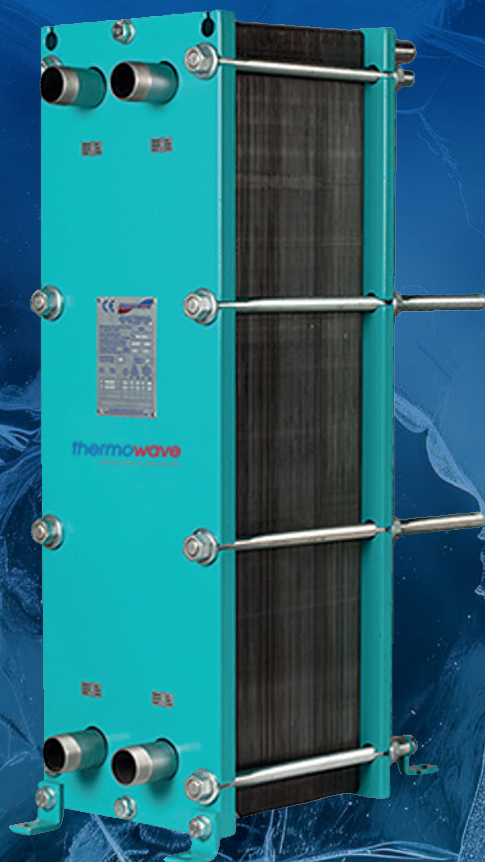



thermowave GmbH is a leading manufacturer of plate heat exchangers configured according to customer specifications in a wide range of materials, frame designs and sizes. Its head office is in Berga halfway between Göttingen and Leipzig.

The product portfolio covers everything from standard heat exchangers for HVAC applications to highly specialised apparatuses for industrial refrigeration, the food and beverages industry, the chemical and process industry, and the energy sector.

10 000 sqm
Production area

3000
Units per years



30
years

A quarter-century quality and experience

Rapid expansion of product portfolio and equipment

The product portfolio was already undergoing expansion as a laser-welding machine now complemented the machine park, making it possible to also offer welded modules.

The product range as well as the technical equipment of the production facilities also continued to grow continuously in the subsequent period. Three product lines leading to the company's decision to build a second production hall for even more sophisticated plate heat exchangers.

Quality experience

Qualified and motivated staff ensure a consistently high level of quality across all products to the benefit of their customers. thermowave's experience in the industrial transfer of heat allow them to develop new innovative products to launch onto the market.

thermolineECO Flexible and high efficient solution Gasketed

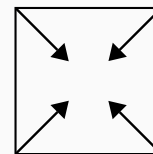

COMPACTY

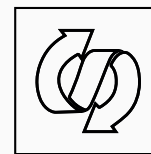

VERSATILITY

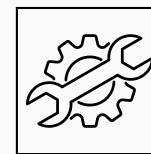

EASY
MAINTENANCE



HIGH TRANSFER
EFFICIENCY

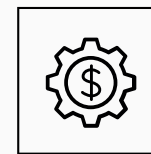

COSTS SAVING

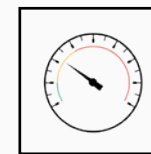

HIGH PRESSURES
-1/16 BAR

Key features

Advantages

- High corrosion resistance
- Fail-safe operation
- Compact design, low space requirements
- Capacity can be adjusted subsequently by adding or removing plates
- Excellent fouling resistance
- Energy-efficient

Energy-saving operation

- Efficient heat exchanger for small Δt_m
- Ideal ratio between heat transfer and pressure drop

Rack frames

- Painted carbon steel

Service friendly

- Low weight
- Compact design
- Easy to clean

Connection variants

- Stud bolts with lining
- Threaded coupling

Available accessories

- Stainless steel protection sheet
- Counter flange and screw
- Hook wrench

Gaskets

- NBR
- EPDM

Plate heat exchangers from the thermolineECO series are characterized not only by their superior dynamic performance but also by their extremely high stability and efficiency.

thermolineECO products can be adjusted to their operating conditions for ideal results thanks to their combination of tried and tested technology with a particularly compact design. thermolineECO plate heat exchangers are designed as a highly standardized modular construction system and can be delivered at a fair price/performance ratio within a few days.

Frame types

Standard configuration

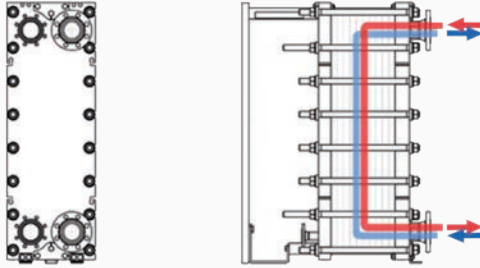

Plates range

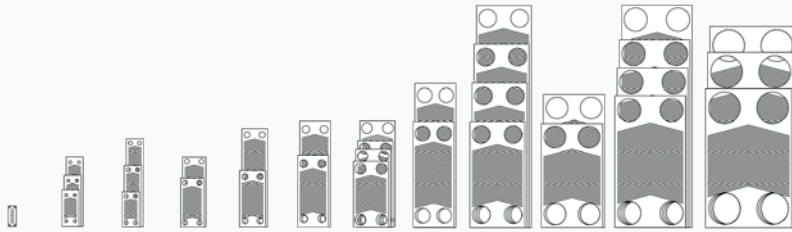

Port diameter (DN)	25	40	50	65	80	100	150	200	250	300	350	450
Length max. (mm)	287	981	1236	986	1383	1495	1498	2034	3122	1872	3126	2831
Width max. (mm)	116	244	246	329	369	437	496	586	774	868	995	1215
Length / Width	2.47	4.02	5.02	2.99	3.74	3.42	3.02	3.47	4.03	2.15	3.14	2.33

Plates types



StandardLine plates

Thermodynamically soft pattern
 High flow rate
 Low pressure drop
 Wide range of applications
 Also suitable for viscous fluids and shear-sensitive media
 Gentle treatment of products
 Corrugation depths from 3.5 to 4 mm

PowerLine plates

Thermodynamically hard pattern
 Very high heat transfer coefficients
 High thermal efficiency
 Low filling volume
 Suitable for homogeneous and low viscous fluids
 Corrugation depths from 2.0 to 2.5 mm

High flexibility and versatility

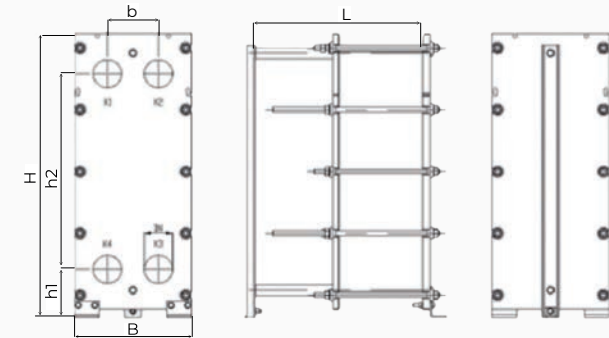

Technical data

EL	Frame type	H	B	L	h1	h2	b	Nominal width	bar	m ²	kg	dm ³
90	E	755	310	250-500	108	565	125	DN 40	-1 / 16	11	80-180	0-12
150	E	1015	310	250-500	108	825	125	DN 40	-1 / 16	17	110-240	0-17
250	E	1145	510	500-1500	198	774	256	DN 100	-1 / 16	88	390-970	0-95
400	E	1519	475	500-1500	168	1207	212	DN 80	-1 / 16	124	370-1130	0-129
500	E	1625	510	500-1500	198	1255	256	DN 100	-1 / 16	157	540-1490	0-157
650	E	1750	706	500-1500	297	1205	305	DN 150	-1 / 16	138	900-1970	0-180

Your applications at a glance

APPLICATION	PRODUCT	MEDIA
System separation	thermolineECO	Water Ethylene glycol Propylene glycol NaCl CaCl ₂ Pekasol Tyfoxit Tyfocor Dowcal Tempering Floweis
Free cooling	thermolineECO	
Heat Recovery	thermolineECO	
Distric cooling	thermolineECO	
Distric Heating	thermolineECO	

References

BMW Production Leipzig



Hexco



Instal Lublin





Website



LinkedIn

EXPERT OF PLATE HEAT EXCHANGERS

Makes life fresh



thermowave
Eichenweg 4
06536 Berga
GERMANY

www.thermowave.eu

thermowave
Brand of Nexson Group